



POWER INVERTER
WITH PURE SINE WAVE



SSI PRO Series

Installation and
Operating Instructions

ACTIVE

Table of Contents

Welcome.....	1
Scope of Delivery	2
Safety Instructions	2
Product Overview.....	4
Installation	7
Connections and Commissioning.....	10
Operation.....	14
Battery and Solar Charger	17
ECO and UPS Mode.....	21
Safety Features	26
Troubleshooting.....	28
Technical Specifications.....	31
The SSI PRO in the ECTIVE Eco System	32
Service and Complaints.....	34
Warranty	35
Disposal.....	35
Stay in Touch	36

► Ready to get ECTIVE!

Quick-Start Guide

1. First familiarise yourself with the safety instructions on p. 2.
2. Install the ECTIVE SSI PRO inverter in accordance with the instructions on p. 7.
3. Ensure that the inverter is switched off, connect your supply battery and, if necessary, other power sources such as shore power or solar panels, taking into account the instructions in the ‘Connections and commissioning’ section.
4. Supply your consumers with high-quality alternating current!

Welcome

Hi, nice to meet you! Ready to get ECTIVE?

Thank you for choosing an ECTIVE SSI PRO inverter!

Devices in the SSI PRO series are the absolute top class of the ECTIVE inverter range. They provide high-quality alternating current with a pure sine wave, which can also be used to operate sophisticated and complex electronic loads: Power just like from a 230 V earthed socket at home - anytime and anywhere. Thanks to special additional features such as a quiet fan, an integrated residual current circuit breaker with overcurrent protection and particularly powerful charger and charge controller, these inverters really deserve the 'PRO' suffix.

In order to supply even the most demanding electronic loads with clean power, the inverter converts direct voltage, such as that provided by a utility battery, into alternating voltage. Thanks to numerous protection mechanisms, durable power electronics and intelligent microprocessor control, SSI PRO inverters guarantee a high overload capacity and can therefore also supply loads with high starting currents or short-term high peak consumption without restrictions. This means that nothing stands in the way of a self-sufficient power supply for the most diverse and demanding devices.

To maximise flexibility, inverters from the SSI PRO series offer the option of using different power sources. If a shore power connection is available, this can not only supply consumers with energy via the inverter, but can also charge the connected supply battery thanks to the IUoU charger built into the SSI PRO. SSI PRO inverters are of course compatible with all ECTIVE batteries and, in addition to conventional wet batteries, also support advanced batteries with AGM, gel or lithium batteries. With practical functions such as mains or battery priority switching, operation can be customised to individual requirements at any time.

Finally, absolute self-sufficiency is made possible by the built-in MPPT solar charge controller. Thanks to the advanced Maximum Power Point Tracking technology, the full potential of the connected solar panels can be utilised - for a truly mobile and independent power supply.

Scope of Delivery

Products in the ECTIVE SSI PRO series include the following elements. Please check that the scope of delivery is complete before installation and commissioning:

- **1 × ECTIVE SSI PRO-Inverter**

High-quality inverter with integrated IUoU charger, MPPT solar charge controller, Please refer to the list below for the technical details of your model.

- **1 × Quick-Start-Guide**

Quick start guide with important safety instructions

Device	Continuous Power	Input Voltage	Output Voltage*	Current (Charger)	Current (Solar)	Weight	Dimensions
SSI 10 PRO	1000 W	12 V	230 V	20 A	40 A	6,0 kg	405 × 220 × 150 mm
SSI 15 PRO	1500 W	12 V	230 V	30 A	40 A	7,0 kg	430 × 220 × 150 mm
SSI 20 PRO	2000 W	12 V	230 V	30 A	40 A	8,3 kg	475 × 220 × 150 mm
SSI 25 PRO	2500 W	12 V	230 V	40 A	40 A	8,9 kg	505 × 220 × 150 mm
SSI 30 PRO	3000 W	12 V	230 V	40 A	40 A	9,3 kg	515 × 220 × 150 mm

*AC voltage fluctuations: max. 10 %, frequency: 50 Hz ± 1 Hz

Safety Instructions

Read the operating instructions carefully before installing and using your ECTIVE PRO inverter. Only use the device in accordance with the intended use described therein and observe the following safety instructions:

- Keep the inverter away from naked flames, sparks and heat sources as well as dust and moisture. Protect the device from impact and damage. Switch off the inverter for cleaning and only use dry cloths.
- Keep children away from the inverter.
- Avoid short circuits and polarity reversals at all costs.

-
- Do not open the housing of the inverter under any circumstances. Maintenance and repairs may only be carried out by a specialist who is familiar with all current guidelines (e.g. VDE guidelines). Ensure adequate ventilation in accordance with the instructions in the 'Installation' section.
 - The inverter may only be connected to a power grid via the DC input, whereby the input voltage of 12 V must not be exceeded. Connecting to higher voltages will cause the fuse to blow immediately and can lead to irreparable damage to the inverter.
 - Never connect an AC voltage source to the 230 V output of the inverter (earthed socket)! Such a connection poses a risk to life as well as immediate and irreparable damage to the inverter.
 - Use cable sets with the correct cross-section. Observe the instructions in the 'Connections and commissioning' section. The 230 V output cable and DC supply cables must never be laid together in the same cable duct.
 - Observe the maximum total output of the connected loads. Some loads require a short-term starting current at start-up, which can be significantly higher than the regular operating current. For this purpose, ECTIVE SSI PRO inverters can supply 150 % power for 10 seconds or 200 % power for 2 seconds.
 - If the recommended total capacity (or the recommended continuous discharge current in the case of lithium batteries) is not reached, voltage dips may result in a loss of performance or severe restrictions on use.
 - The device is equipped with safety mechanisms to prevent dangerous electric shocks. To ensure the highest possible level of protection during operation, the inverter's earth connection must be connected to a protective earth. The inverter must not be used in vehicles in which the positive pole is connected to the vehicle body.
 - When not in use, switch off the inverter at the main switch after disconnecting it from the shore and solar power. Current is also drawn when the inverter is idle, which may result in deep discharge of the connected battery. Observe the notes in the section 'Notes on operation'.
 - The inverter has various safety functions that automatically switch off the AC output in the event of faults. These include overheating, overpower and input voltage that is too high or too low. Observe the instructions and fault diagnosis in the 'Troubleshooting' section. Eliminate sources of faults immediately, as repeated switching on in the event of a fault can lead to damage to the device.
 - Failure to comply with these safety instructions and the operation described in the manual will invalidate the warranty provided by the manufacturer. The manufacturer accepts no liability for damage caused by improper use.

Product Overview

Regardless of which model of the ECTIVE SSI PRO series you have chosen, the connections and operating elements are arranged according to the following overview. Please observe the technical specifications and performance values applicable to your model when using it.



ECTIVE SSI 10 PRO



ECTIVE SSI 15 PRO



ECTIVE SSI 20 PRO



ECTIVE SSI 25 PRO



ECTIVE PRO 30 SSI

Connections and controls

1. MC4 solar connections
2. 230 V socket
3. Main switch: On/Off/ECO/UPS mode
4. Status LEDs (see next page)
5. Connection for remote control
6. USB port
7. DIP switch for selecting the battery technology
8. Charge level LEDs
9. Residual current circuit breaker with overcurrent protection
10. Alternating current output
11. Shore power connection
12. Protective earthing
13. Direct current connection positive pole*
14. Direct current connection negative pole*
15. Fan

* Connections for e.g. battery

SSI 10 PRO, SSI 15 PRO: M8

SSI 20 PRO, SSI 25 PRO, SSI 30 PRO: M10

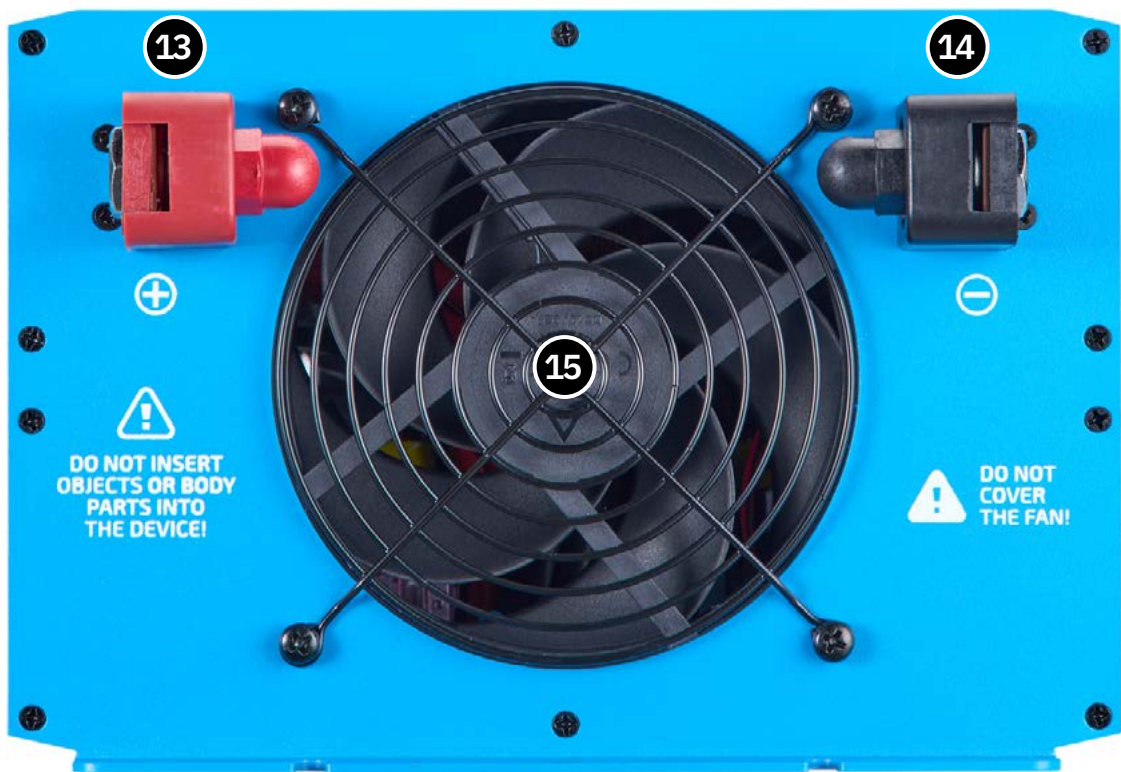
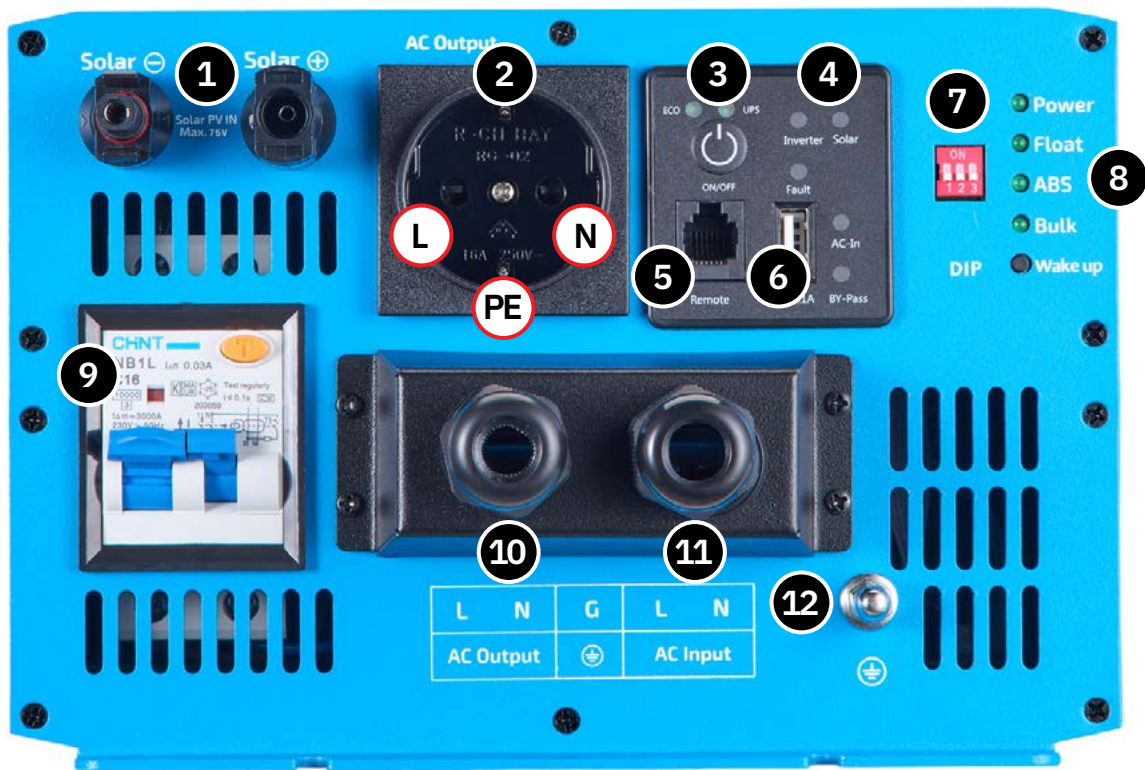

Status LEDs

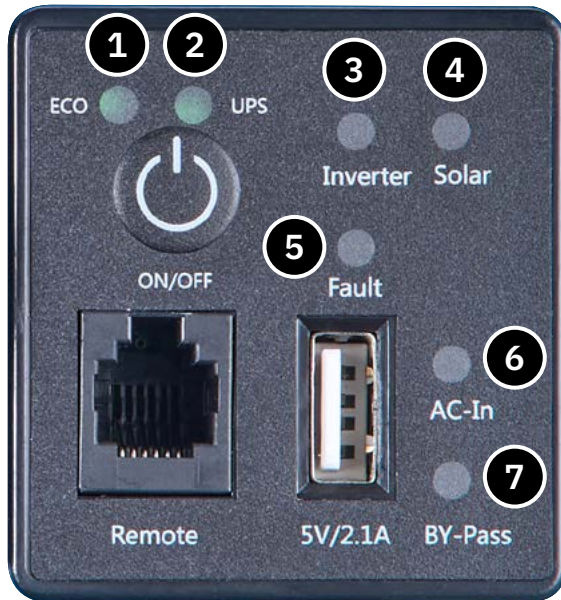

1. **ECO**: Battery priority
2. **UPS**: Uninterruptible power supply
3. **Inverter**: Inverter in operation
4. **Solar**: Solar power is available
5. **Fault**: An error has occurred (see p. 27)
6. **AC-In**: Shore power is present
7. **By-Pass**: Mains priority circuit

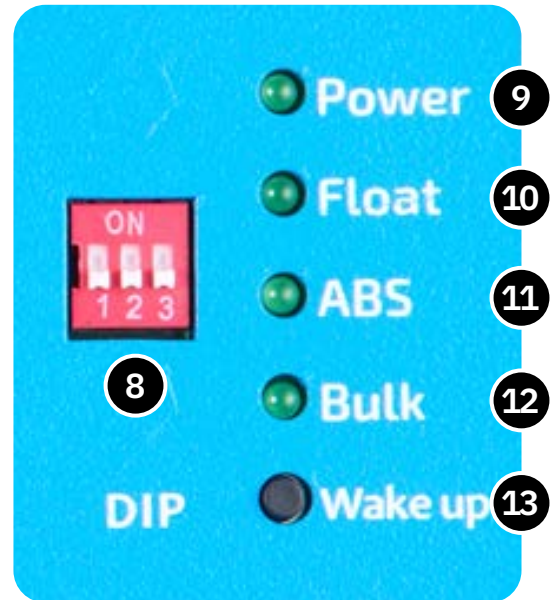

8. **DIP-Schalter** for selecting the battery technology (see p. 20)
9. **Power**: The integrated charger is on
10. **Float**: Float charging
11. **ABS**: Residual charge (absorption)
12. **Bulk**: Main charge
13. **Wake up**: Reactivation of the battery after blocking by BMS (only for LiFePO₄)

Installation

Please observe the following installation instructions when installing your ECTIVE SSI PRO inverter:

- Disconnect the inverter from the power supply before installing or working on the device.
- Never open the housing of the inverter.
- Only mount or screw the inverter to solid mounting surfaces.
- Install the inverter in a location where it is protected from direct sunlight, heat sources, dust and moisture.
- The inverter can be installed both horizontally and vertically.
- Lay the cables so that they are not under tension or pull on the connections.
- When used on boats, inadequate sealing can cause corrosion damage. The installation should therefore be carried out by appropriately trained personnel.
- Use empty conduits or cable ducts to protect the cables.
- Never lay the 230 V output cable and DC supply cables together in the same cable duct.
- To ensure the highest possible level of protection, the inverter's earth connection must be connected to a protective earth. The inverter must not be used in vehicles in which the positive pole is connected to the vehicle body.
- As the inverter radiates heat during operation, it should be installed away from objects that are sensitive to high temperatures.
- Never cover the ventilation slots or the fan. To ensure good ventilation, the distance between the ventilation elements and the nearest surface must be at least 10 cm. If overheating occurs due to insufficient ventilation, the inverter switches off automatically.

Orientation of the inverter

The inverter can be mounted both horizontally and vertically.



Minimum distance for sufficient ventilation

The distance between ventilation elements and the nearest surface must be at least 10 cm. Ventilation slots and fans must not be covered.

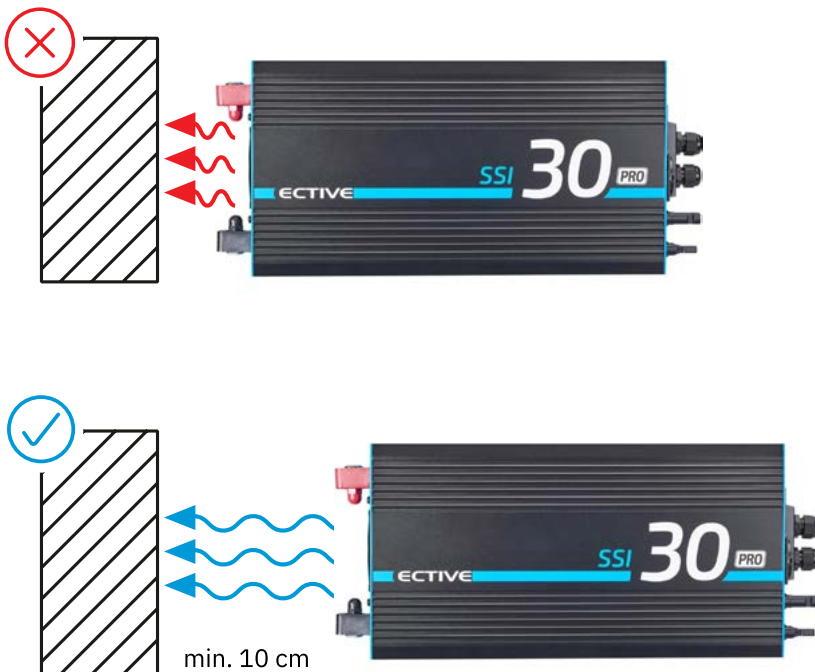

Dimensions of the inverter

When installing in confined spaces, observe the minimum distance of 10 cm in front of the ventilation elements!

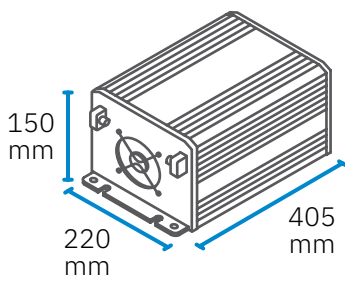

ECTIVE SSI 10 PRO

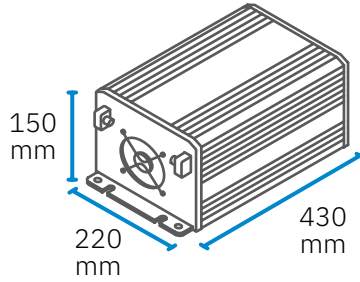

ECTIVE SSI 15 PRO

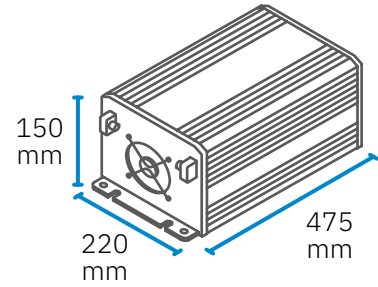

ECTIVE SSI 20 PRO

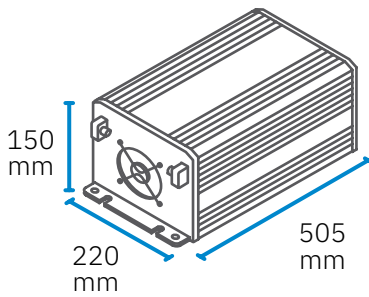

ECTIVE SSI 25 PRO

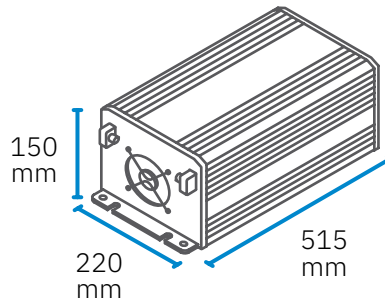

ECTIVE SSI 30 PRO

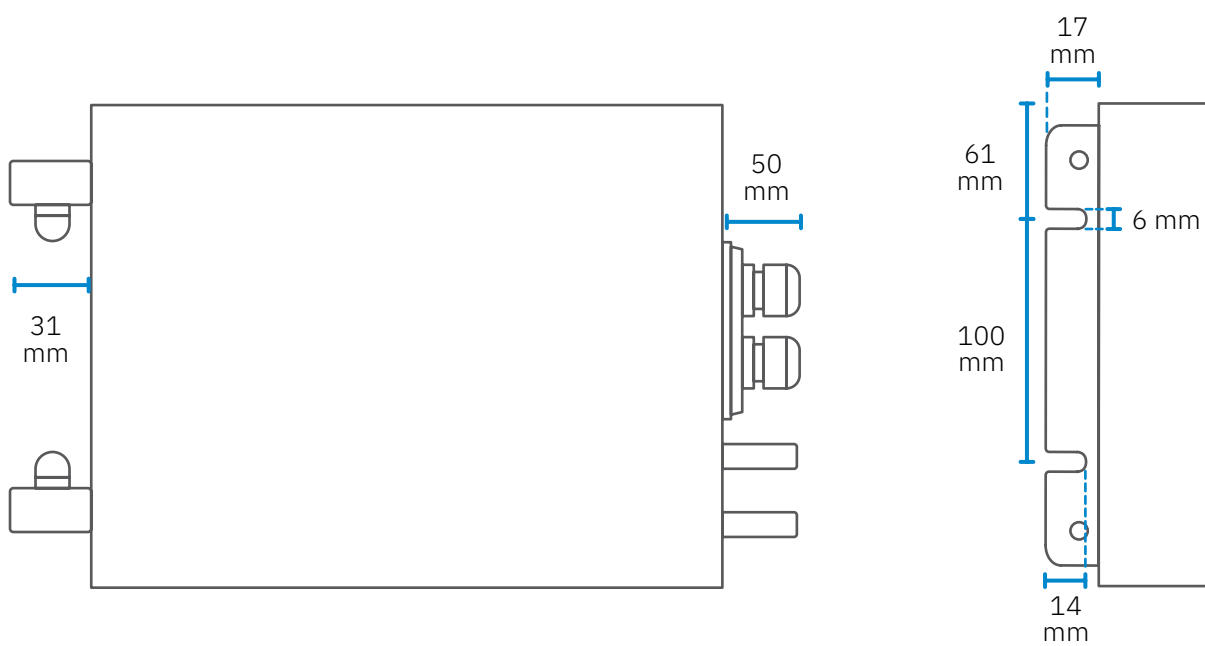

Protruding connections

Mounting panel

Connections and Commissioning

Observe the following instructions when connecting and commissioning your **ECTIVE SSI PRO** inverter. In addition, all instructions in the ‘Safety instructions’ section must be followed to ensure safe operation.

- Inverters of the ECTIVE SSI PRO series are intended exclusively for use in stand-alone, so-called ‘off-grid’ areas. Never connect an AC voltage source to the 230 V output of the inverter (earthed socket)! Such a connection poses a risk to life as well as immediate and irreparable damage to the inverter.
- The inverter may only be connected to a power grid via the DC input, whereby the nominal input voltage of 12 V must not be exceeded. Connecting to higher voltages will cause the fuse to blow immediately and can lead to irreparable damage to the inverter.
- Ensure a suitable battery capacity or, in the case of lithium batteries, a suitable continuous discharge current. Follow the instructions on the following page.

Connecting the inverter and putting it into operation

- First make sure that the inverter is disconnected from the solar and shore power and switched off at the main switch (no LEDs are lit). If the input voltage is a supply device such as a generator, switch this off as well.
- Use the DIP switches on the inverter to set the correct battery technology. Observe the following diagram:

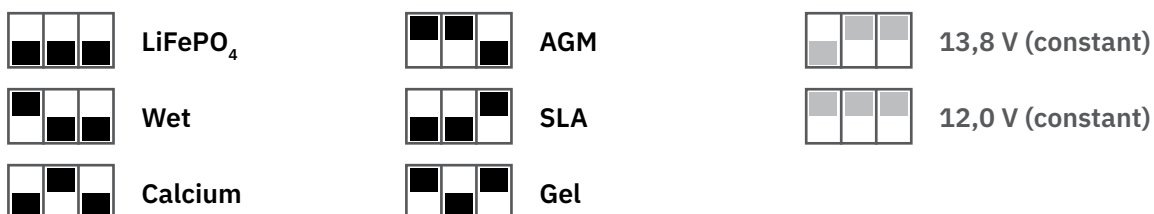

- Connect the inverter to the battery, paying close attention to the polarity. During this step, sparking may occur due to the charging of the internal capacitors. Be sure to use cables with the appropriate cable cross-sections specified on the next page, as well as an appropriate fuse.
- If necessary, connect the inverter to other power sources such as solar panels, shore power or a generator.
- Switch on the inverter at the main switch and wait approx. 12 seconds for the inverter to start up. If solar or shore power is connected, the device switches on automatically

Required battery capacities, cable cross-sections and fuses

When planning and installing your power supply, observe the specifications applicable to your inverter model. If the total capacity of the batteries falls below the recommended level, this may result in a loss of performance or severe restrictions on utilisation due to voltage dips.

Device	Battery Capacity (Wet, Gel, AGM)	Battery Capacity (LiFePO ₄)	Continuous Discharge Current (LiFePO ₄)	Recommended cross-section for cable length				Battery fuse
				100 cm	150 cm	200 cm	300 cm	
SSI 10 PRO	≥ 160 Ah	≥ 90 Ah	85 A	16 mm ²	25 mm ²	35 mm ²	50 mm ²	175 A
SSI 15 PRO	≥ 250 Ah	≥ 125 Ah	125 A	10 mm ²	16 mm ²	25 mm ²	35 mm ²	250 A
SSI 20 PRO	≥ 320 Ah	≥ 180 Ah	165 A	16 mm ²	25 mm ²	35 mm ²	50 mm ²	350 A
SSI 25 PRO	≥ 400 Ah	≥ 200 Ah	200 A	25 mm ²	35 mm ²	50 mm ²	50 mm ²	425 A
SSI 30 PRO	≥ 480 Ah	≥ 250 Ah	250 A	25 mm ²	35 mm ²	50 mm ²	50 mm ²	500 A

DC connections (for battery): SSI 10, SSI 15: M8

SSI 20, SSI 25, SSI 30: M10

Using the connections

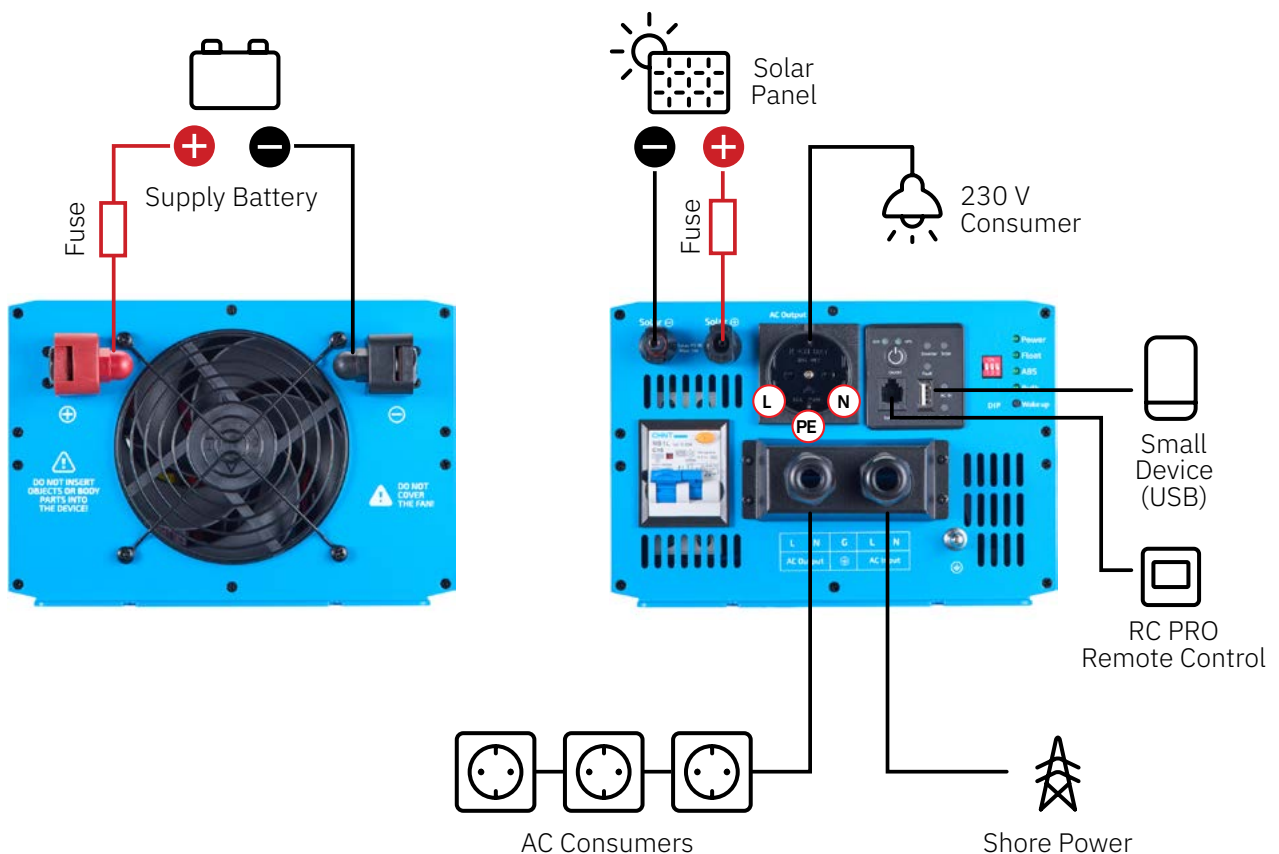

Possible use of shore power

Two systems can be designed for the use of shore power, e.g. the power supply for a caravan on a campsite: If the entire power supply runs via the ECTIVE PRO inverter, no additional fuse is required as the inverter has an integrated residual current circuit breaker with overcurrent protection switch. However, if the system includes a branch before the inverter to which other sockets are connected, this part of the grid must be protected separately by an RCD. In any case, the connections to the supply batteries and solar panels must be fitted with suitable fuses.

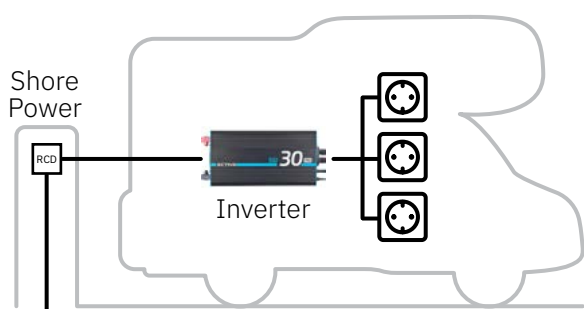

Full protection via the inverter.

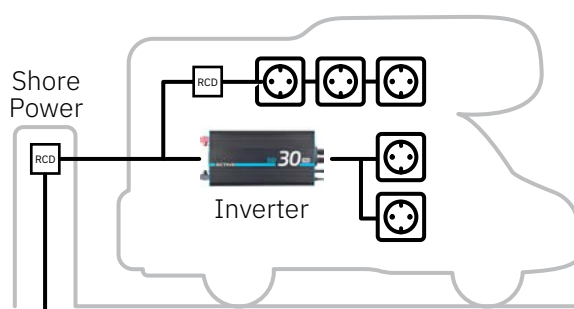

Additional RCD protection necessary.

Parallel connection of batteries

In order to provide the inverter with a higher total capacity, several identical batteries can be connected in parallel to form a battery bank. The voltage does not change when connected in parallel, so make sure you only use 12 V batteries!

In the following example, three ECTIVE LC 100 LiFePO4 batteries with a capacity of 100 Ah each were connected in parallel. The total capacity is 300 Ah and is therefore sufficient to operate an SSI 30 PRO as intended. A suitable fuse (see table on page 11) must be used when connecting the positive terminals.

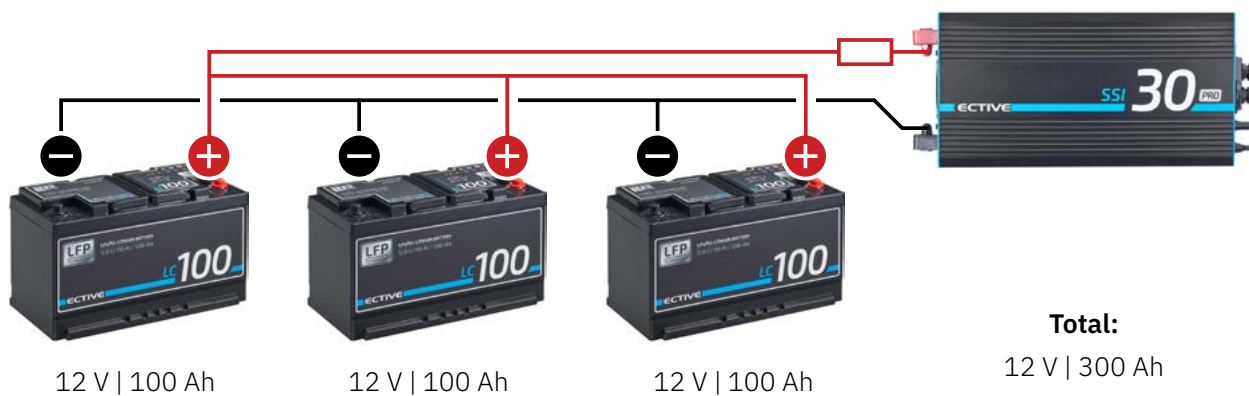

Personal protection in the TN network

Inverters from the ECTIVE PRO series provide a so-called TN grid. This is an 'earthed system' - the neutral point of the system is directly earthed via the operating earth electrode and all bodies of the individual loads are connected to the operating earth electrode (PE).

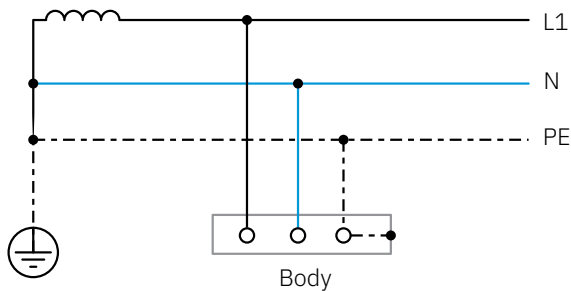

Electrical installations must fulfil the requirements of personal protection in two ways:

Basic protection:

Protection of the person by preventing direct contact with the live parts of the equipment. This includes, for example, complete insulation of cables and covering them with an enclosure.

Fault protection:

Protection of the person against electric shock in the event of indirect contact, e.g. touching a live enclosure. This can be the case if, for example, a defective cable comes into contact with the conductive, earthed enclosure. In this situation, the basic protection has failed and the safety of the person must be guaranteed by the fault protection.

In TN systems, overcurrent protection devices and residual current devices in particular must be provided to protect against disconnection or fault signalling.

If a person touches a conductive enclosure that is energised due to a short circuit in a correctly planned and designed TN system, a high residual current immediately flows via the person to the power source. The system must therefore have suitable protective mechanisms such as fuses and RCDs that disconnect the circuit before people can be harmed. In an earthed system, a single fault will result in the entire system being switched off.

You can find more information on personal protection in different types of network here:

active.de/mediafiles/Datenblatt/active/Inverter-2024/ECTIVE-Personenschutz-im-IT-und-TN-Netz.pdf

Operation

To ensure safe and proper operation, please observe the following instructions and technical conditions.

Operating Conditions

- **Operating temperature:** -15 °C to 40 °C
- **Storage temperature:** -40 °C to 85 °C
- **Relative humidity:** 20% to 90%

Please note that performance may be reduced at ambient temperatures above 40 °C. In addition, the inverter has built-in overheating protection, which automatically switches off the device if the internal temperature exceeds 75 °C.

Maximum Total Output

Ensure that the total output of all connected loads does not exceed the maximum output of your inverter model. This also applies if the loads are supplied exclusively with shore power (bypass function in UPS mode).

Consumers with continuous currents over 10 A must not be connected to the earthed socket. Instead, use the direct connection on the AC terminal ('AC output').



Starting Currents - Power When it Counts

Some loads require a short-term starting current at start-up, which can be significantly higher than the regular operating current. Integrated protective circuits, durable power electronics and intelligent microprocessor control of the ECTIVE SSI PRO inverters guarantee a high overload capacity. This means you can also use loads with high starting currents or short-term high peak consumption safely and without restrictions:

- **150 %** power for 10 seconds
- **200 %** power for 2 seconds

Errors and Troubleshooting

Thanks to numerous built-in protection mechanisms, the ECTIVE SSI PRO inverter switches off automatically in the event of various faults. Status LEDs and any acoustic signals indicate the problem and allow the fault to be rectified. In such cases, follow the instructions in the 'Troubleshooting' section.

ECO Mode (Battery Priority) and UPS Mode (Mains Priority)

Inverters in the ECTIVE SSI PRO series can be operated in **ECO mode** or in **UPS mode**.

In **ECO mode** (battery priority), the inverter supplies the loads with power from the connected battery, even if the system is connected to shore power. This can be useful, for example, if there is plenty of solar power available. If the battery voltage falls below 11 V, e.g. because there is no more solar power available, the inverter automatically switches to UPS mode. If the battery is then charged so that the battery voltage is 14.2 V again, the inverter switches back to ECO mode.

The **UPS mode** (mains priority) provides an uninterruptible power supply: Connected 230 V consumers are supplied with shore power as a priority, while available solar power and shore power is used to charge the connected batteries. If solar power is no longer available, the inverter switches to battery charging using shore power after approx. 30 seconds. If the connection to the shore power is disconnected, the inverter switches to battery operation within 16 ms.

The green ‘ECO’ and ‘UPS’ LEDs on the inverter control panel make it easy to recognise which mode the device is currently operating in. In addition, the ‘Inverter’ and ‘By-Pass’ LEDs indicate whether the inverter is currently converting direct current from the battery into alternating current to operate loads (‘Inverter’) or whether shore power is being fed through directly to the loads (‘By-Pass’).

To **switch between the modes**, press and hold the main switch for a few seconds until the LED for the desired mode lights up and the other LED goes out. Press and hold the button for a further two seconds and then release it. For technical reasons, the other LED may shimmer slightly green depending on the lighting conditions. In any case, the brightly lit LED indicates which mode the inverter is in.

For more detailed information on the behaviour of the inverter in the respective modes, please read the section ‘Battery and Solar Charger’.

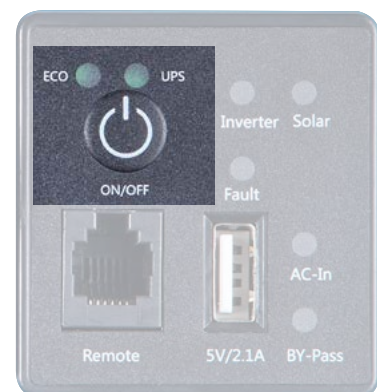

Idle Current

The inverter also draws current when idling. This can lead to a deep discharge of the connected battery, which can cause permanent damage to the battery. Therefore, switch off the inverter when not in use: First disconnect it from the shore power and then switch off the device at the main switch. To do this, press and hold the button for several seconds until the status LED changes from 'ECO' to 'UPS' or vice versa. Then release the button. It is not possible to switch off the inverter as long as solar or shore power is present. In this case, the inverter switches back and forth between ECO and UPS mode when the main switch is pressed.

Device	Idle Current
SSI 10 PRO	approx. 0.5 A
SSI 15 PRO	approx. 0.65 A
SSI 20 PRO	approx. 1.0 A
SSI 25 PRO	approx. 1.0 A
SSI 30 PRO	approx. 1.2 A



Press and hold the **main switch** for several seconds until the LEDs change. Then release the button to switch off the inverter. Only possible if there is neither shore power nor solar power.

Overwintering & Prolonged Non-Use

If the inverter will not be used for an extended period of time, please observe the following instructions to protect your battery from discharging:

- Disconnect the inverter from all connected power sources and solar panels.
- Disconnect all loads from the inverter.
- Switch off the inverter.
- Disconnect the battery from the inverter by disconnecting the connecting cables or using a circuit breaker to prevent deep discharge of the battery.
- Store the inverter out of the reach of children in a dry place, protected from direct sunlight.

Battery and Solar Charger

Inverters in the ECTIVE SSI PRO series have an integrated battery charger with IUoU charging characteristic and an advanced MPPT solar charge controller.

Integrated Battery Charger

The right charging process for all battery technologies: In addition to standard wet batteries, the integrated multi-stage charger is also suitable for AGM, gel and LiFePo4 batteries (with BMS). An optimum charging characteristic can be selected for each battery technology. To do this, set the DIP switches on the inverter according to the overview on p. 20.

MPPT Solar Charge Controller

Maximum efficiency in all situations: The integrated MPPT solar charge controller ensures that the maximum possible output of the connected solar modules is utilised. In contrast to conventional PWM charge controllers, the full potential of the solar modules is utilised, completely independent of the difference between battery and module voltage.

Technical Properties

Model	Charging current (charger)	Charging current (solar charge controller)
SSI 10 PRO	20 A	40 A
SSI 15 PRO	30 A	40 A
SSI 20 PRO	30 A	40 A
SSI 25 PRO	40 A	40 A
SSI 30 PRO	40 A	40 A

Efficiency (charger): up to 92 %

Efficiency (solar charge controller): 97 %

Solar input voltage: 25 to 75 V

Max. Solar input power: 600 W

The Three Charging Phases

Both the integrated charger and the MPPT solar charge controller charge connected batteries with a fully automatic 3-stage IUoU charging characteristic that is optimised for each battery technology. The system runs through the following three phases over the course of charging:

Main Charge („Bulk“): The battery is charged at a constant current and carefully increasing voltage up to a predefined maximum voltage value until 80% of the total charge has been reached.

Residual Charge („Absorption“): The battery is fully charged from 80 % to 100 % capacity using a constant voltage and gradually decreasing currents. The gradually decreasing current ensures that the terminal voltage does not become too high during full charging. The charging voltage depends on the battery technology, which can be selected using the DIP switches on the device.

Float Charge („Float“): The battery is kept evenly at ‘float’ voltage without overcharging or damaging it. The battery voltage is constantly monitored during this charging phase. If it falls to a predefined level, the battery is recharged to 100 % by pulse charging. In this way, it is constantly kept between 95 % and 100 % state of charge.

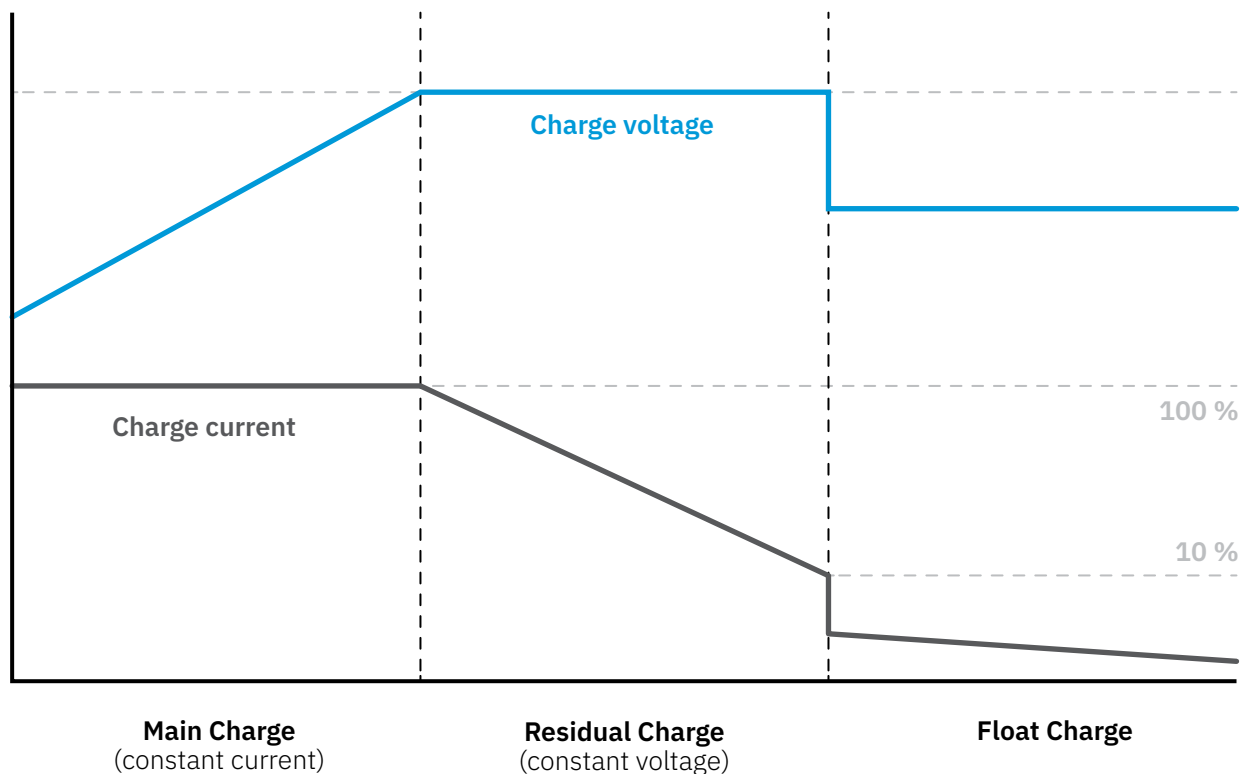

The current charging phase of the system can be easily recognised by the corresponding status LEDs:

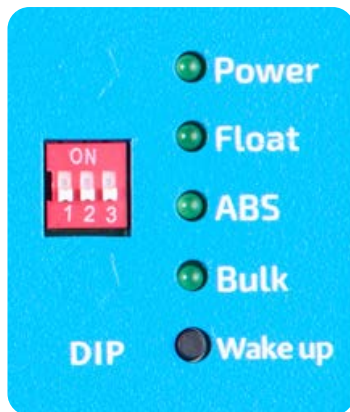

Power: The charger is working.

Float: Trickle charge.

ABS: Residual charge.

Bulk: Main charge.

Wake up: A connected LiFePO₄ battery is reactivated after it has been switched off by its internal BMS.

Note that the charging and discharging of the batteries depends on whether the inverter is operating in ECO mode or UPS mode.

In ECO mode, no shore power is used to operate utilities or charge batteries, even if the inverter is connected to shore power. The consumers are supplied with power from the batteries and these are only recharged with solar power - if available.

In UPS mode, the batteries are charged with both solar and shore power.

Follow the instructions in the section 'ECO and UPS Modes'.

► Useful accessories

not included in scope of delivery.







With the ECTIVE RC PRO remote control, you always have many relevant values of your system in view and can conveniently choose between ECO, UPS mode and pure inverter operation at any time.

Please note: The conventional ECTIVE RC1, RC2, RC3 and RC4 models are **not** compatible with PRO series inverters.



Setting the battery technology using DIP switches

Before connecting a battery to the inverter, set the DIP switches to the battery technology used according to the diagram below. The inverter uses a specially adapted charging characteristic for each battery technology to ensure efficient and gentle charging.

DIP switch	Battery Technology	Voltage (Main and Residual Charge)	Voltage (Float Charge)
	LiFePO ₄	14,6 V	-
	Wet	14,8 V	13,8 V
	Calcium	15,0 V	13,8 V
	AGM	14,6 V	13,4 V
	SLA	14,4 V	13,4 V
	Gel	14,2 V	13,2 V

Constant Voltage

	13,8 V
	12,0 V

ECO and UPS Modes

The following overview describes the behaviour of the inverter in ECO or UPS mode under various conditions. The different scenarios are shown graphically in the diagram on the next page. A general explanation of the two modes and how to switch between ECO and UPS mode can be found on page 15.

ECO Mode

In ECO mode, connected consumers are supplied with power from the battery. Even if shore power is available, it is not used to charge the batteries. If the battery voltage falls below 11 V, the inverter automatically switches to UPS mode. Once the batteries have been charged to such an extent that the battery voltage is back to 14.2 V, the device switches back to ECO mode.

UPS Mode

Szenario 1 (Day): Shore power and solar power are available

T0 - T5: (Bypass power)

The inverter feeds shore power through to supply connected loads, the 'Bypass' LED lights up. Batteries are charged with shore power and, if available, with solar power.

Szenario 2 (Night): Shore power fails during the night

T5 - T6: (UPS function/inverter function)

If the shore power supply fails and there is no solar power available, the system automatically switches from the bypass function to the inverter function. The connected batteries are used to power the consumers and are charged up to a battery voltage of 11 V.

Szenario 3 (Night): Shore power becomes available again at night after failure

T6 - T9: (Charging with charger)

As soon as shore power is available again, the system immediately switches to bypass mode and the batteries are immediately charged by the integrated charger.

Szenario 4 (Night): Shore power fails a second time during the night

T9 - T10: (deep discharge of batteries, e.g. in an emergency situation)

If the shore power connection is disconnected a second time during the same night, the inverter switches back to inverter mode. The batteries are emergency discharged to a battery voltage of 10.2 V. If the battery voltage falls below this value, the consumers are no longer supplied with power.

Szenario 5: Simultaneous charging according to scenario 4

T10 - T11: (Simultaneous charging after emergency situation)

If both solar and shore power become available again after the occurrence of scenario 4 (emergency discharge to 10.2 V), both power sources are charged simultaneously in order to prevent damage to the batteries as quickly as possible. Simultaneous charging takes place until a battery voltage of 14.2 V is reached.

Graphical Representation of the Scenarios

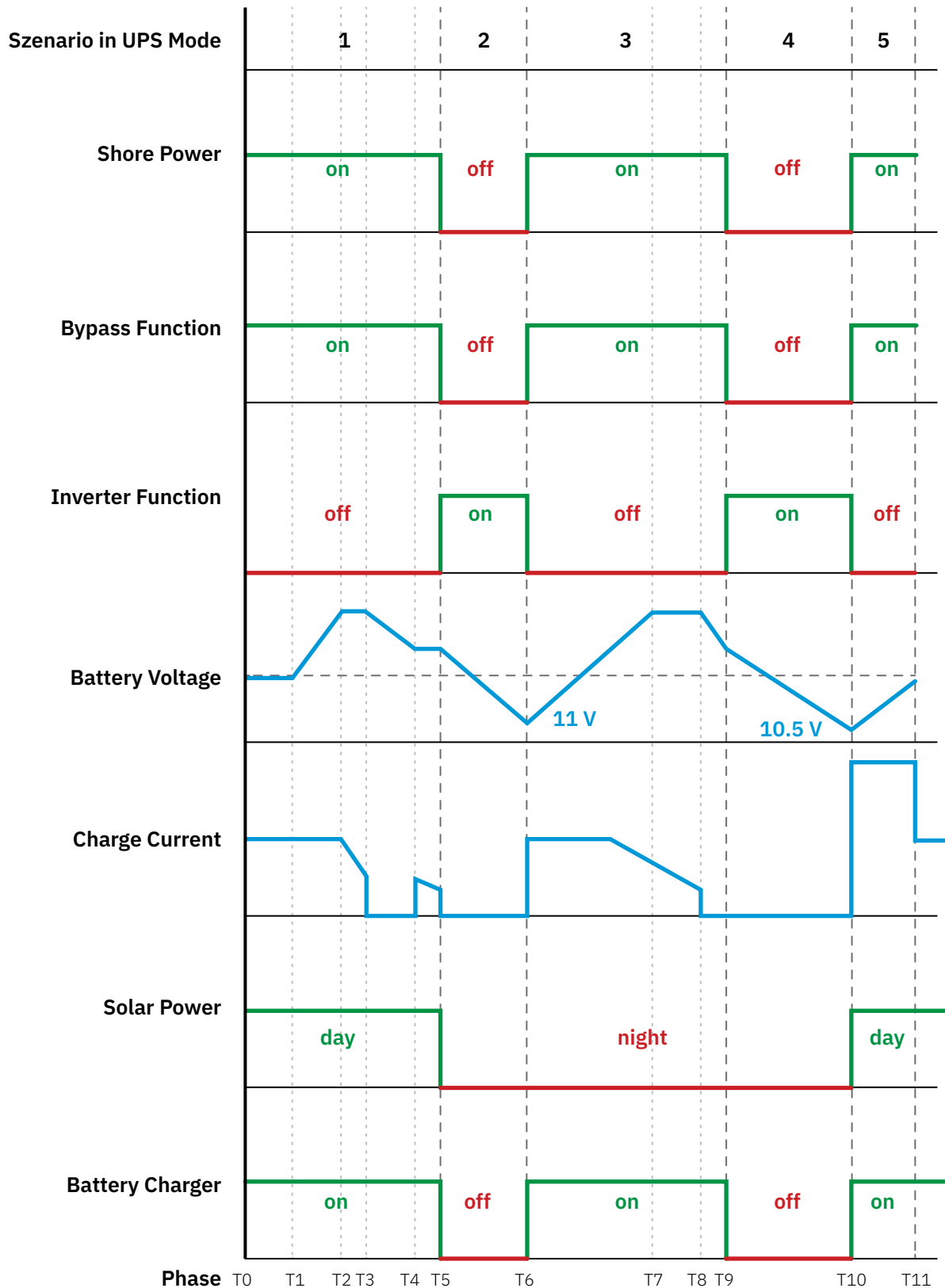

ECO Mode (Battery Priority)

Operating Conditions	AC Charger	By-Pass	Inverter	Solar Charger
<ul style="list-style-type: none"> Shore power available No solar power 	If battery voltage falls below 11 V: charge until voltage reaches 14.2 V	☑	☒	☒
	Battery voltage above 11 V: no charge	☒	☑	☒
<ul style="list-style-type: none"> Shore power available Solar power available 	If battery voltage falls below 11 V: charge until voltage reaches 14.2 V	☑	☒	☑
	Battery voltage above 11 V: no charge	☒	☑	☑
<ul style="list-style-type: none"> No shore power Solar power available 	No charge	☒	☑	☑
<ul style="list-style-type: none"> No shore power No solar power 	No charge	☒	☑	☒

UPS Mode (Mains Priority)

Operating Conditions	AC Charger	By-Pass	Inverter	Solar Charger
<ul style="list-style-type: none"> Shore power available No solar power 	☑	☑	☒	☒
<ul style="list-style-type: none"> Shore power available Solar power available 	☑	☑	☒	☑
<ul style="list-style-type: none"> No shore power Solar power available 	☒	☒	☑	☑
<ul style="list-style-type: none"> No shore power No solar power 	☒	☒	☑	☒

Device is Turned Off

Operating Conditions	AC Charger	By-Pass	Inverter	Solar Charger
<ul style="list-style-type: none"> No shore power No solar power 	☒	☒	☒	☒

Status LEDs in ECO mode



No Shore Power; No Solar Power

UPS: Device is working in ECO Mode*.

Inverter: Device turns DC power from the battery into AC power for the consumers.



Shore power available; No Solar Power

UPS: Device is working in ECO Mode*.

Inverter: Device turns DC power from the battery into AC power for the consumers.

AC-In: Shore power is available but is not used to charge the battery.



No Shore Power; Solar power is available

UPS: Device is working in ECO Mode*.

Inverter: Device turns DC power from the battery into AC power for the consumers.

Solar (Lit): Solar power is available.

Solar (Blinking): Batteries are being charged with solar power.



Shore Power and Solar Power are Available;

UPS: Device is working in ECO Mode*.

Inverter: Device turns DC power from the battery into AC power for the consumers.

Solar (Lit): Solar power is available.

Solar (Blinking): Batteries are being charged with solar power.

AC-In: Shore power is available but is not used to charge the battery.

*For technical reasons, the 'UPS' LED may also shimmer slightly green depending on the lighting conditions. When the battery is charging, the 'Power' LED and the corresponding charging phase LED also light up. Please refer to the explanations in the section 'Battery and Solar Charger'.

Status LEDs in UPS mode



No Shore Power; No Solar Power

UPS: Device is working in UPS Mode*.

Inverter: Device turns DC power from the battery into AC power for the consumers.



Shore power available; No Solar Power

UPS: Device is working in UPS Mode*.

AC-In: Shore power is available but is not used to charge the battery.

By-Pass: Shore power is directly passed through to the 230 V consumers.



No Shore Power; Solar power is available

UPS: Device is working in UPS Mode*.

Inverter: Device turns DC power from the battery into AC power for the consumers.

Solar (Lit): Solar power is available.

Solar (Blinking): Batteries are being charged with solar power.



Landstrom liegt an; Solarstrom liegt an

UPS: Device is working in UPS Mode*.

Solar (Lit): Solar power is available.

Solar (Blinking): Batteries are being charged with solar power.

AC-In: Shore power is available but is not used to charge the battery.

By-Pass: Shore power is directly passed through to the 230 V consumers.

*For technical reasons, the 'UPS' LED may also shimmer slightly green depending on the lighting conditions. When the battery is charging, the 'Power' LED and the corresponding charging phase LED also light up. Please refer to the explanations in the section 'Battery and Solar Charger'.

Safety Features

The following safety functions of the **ECTIVE TSI PRO** inverters protect the user, devices and battery during operation.

- **Overvoltage and Undervoltage Protection**

Switches the inverter off automatically if the set values are exceeded or undercut, prevents damage to the inverter and deep discharge of the supply batteries.

- **Reverse Polarity Protection**

Immediately triggers the inverter fuse if the battery cables are reversed.

- **Soft Start**

Limits the power required when switching on the inverter, thus reducing the load on the batteries and preventing fuse failures.

- **Overload Protection**

Automatically switches off the inverter if the loads place too high a power demand on it.

- **Overheating Protection**

Switches the inverter off immediately at internal temperatures above 75 °C.

- **Short-Circuit Protection**

Switches the inverter off immediately in the event of a short circuit at a load.

- **Residual Current Circuit Breaker With Overcurrent Protection**

Switches the circuit off automatically in the event of residual currents.

- **Warning Signals**

In the event of a fault, acoustic signals and status LEDs draw attention to the underlying problem. Follow the instructions in the 'Troubleshooting' section.

Under certain circumstances, the device may remain switched on even after the AC output has been disconnected. In this standby mode, no-load current continues to be drawn and there is a risk of deep discharge of the connected battery. The AC output of the inverter is automatically switched off in the following fault cases:

- The internal temperature of the inverter exceeds 75 °C.
- The required power is above the continuous power of the inverter or above the short-term maximum power for starting currents.
- The input voltage is either too high or too low.

Please note that damage caused by reverse polarity and short circuits is excluded from liability.

Triggering and Behaviour of Safety Mechanisms

Error	Behaviour of the safety mechanism
Impending undervoltage Input voltage falls below $10.8\text{ V} \pm 0.2\text{ V}$	2 x signal tone, red LED flashes Inverter continues to operate
Actual undervoltage Input voltage drops below $10.2\text{ V} \pm 0.2\text{ V}$	3 x signal tone, red LED flashes Automatic switch-off
Undervoltage in ECO mode (only if shore power is present, otherwise the two lines above apply) Input voltage drops below $11.0\text{ V} \pm 0.2\text{ V}$	Switchover to mains priority circuit. Return to ECO mode when voltage rises above $14.2\text{ V} \pm 0.2$ again
Overvoltage Input voltage rises above $15.5\text{ V} \pm 0.2\text{ V}$	4 x signal tone, red LED flashes Automatic switch-off
Overheating Internal temperature exceeds $75\text{ }^{\circ}\text{C}$	5 x signal tone, red LED flashes Automatic switch-off
Overload due to load	Continuous acoustic signal, red LED flashes Automatic switch-off
Short circuit at the load	11 x signal tone, red LED lights up Automatic switch-off
Polarity reversal (battery cables swapped)	Integrated MOSFET switches off



In the event of an error, observe the **'Fault'** LED and the acoustic signal to identify the problem. Rectify the fault as quickly as possible by following the instructions in the 'Troubleshooting' section.

Troubleshooting

The following overview contains solutions on how you can easily and safely rectify typical faults on the inverter yourself.

- Always follow the instructions in the 'Safety instructions' section when working on the inverter and the system connected to it.
- After rectifying a problem, make sure that the source of the fault has actually been eliminated. Repeated switching on while problems still exist can lead to irreparable damage to the device.
- Avoid short-circuits and polarity reversals at all costs, as these can cause damage to the appliance despite fusing and protective mechanisms.

There is no output voltage although the inverter is switched on.

- The inverter is switched on.
- There is no output voltage.
- The fault LED does not light up and no acoustic warning signal sounds.

Option A: No input voltage is present

1. Check the battery voltage.
2. Check the input fuses.
3. Check all connections to the battery.

Possibility B: Blown fuses due to reverse polarity

1. Replace the blown fuses and connect the cables correctly.
2. If the inverter does not work after replacement, it has probably been damaged. Please contact our customer service.

A single acoustic warning signal sounds.

Possibility A: The connection to the loads has been broken.

- Check the connection between the inverter and the connected loads.

Possibility B: There is a short circuit on the loads.

- Check the connected loads for short circuits.

A double acoustic warning signal sounds and the red error LED flashes.

The threshold value for imminent input undervoltage has not been reached

1. Check the charge level of the battery and recharge it if necessary.
2. Check whether the battery cables have the correct cable cross-section.
3. Check conductive parts (e.g. cables, pole terminals, cable lugs) for damage.

A triple acoustic warning signal sounds and the red error LED flashes.

The actual input voltage has fallen below the undervoltage threshold value

1. Check the charge level of the battery and recharge it if necessary.
2. Check whether the battery cables have the correct cable cross-section.
3. Check conductive parts (e.g. cables, pole terminals, cable lugs) for damage.

A quadruple acoustic warning signal sounds and the red error LED flashes.

The inverter is overheated (internal temperature above 75 °C)

1. Check whether the fan is working. If it is defective, please contact our customer service.
2. Check whether the ventilation inlets and outlets are unobstructed and have sufficient clearance (at least 10 cm) to the nearest surface. There must be enough cool ambient air.
3. Reduce the total power demand of the consumers.

The red error LED flashes continuously.

The maximum short-term power output has been reached.

1. Reduce the total power demand of the loads.
2. Switch off the inverter temporarily.
3. Ensure that the inverter can cool down.

CHARGER: The charger is not working

The input voltage is outside the required minimum or maximum values.

- Use a power source with the correct voltage and frequency.

CHARGER: The charger only supplies low currents

Possibility A: The input voltage is too low.

- Use a power source with the correct voltage.

Possibility B: One or more batteries are not connected or are defective.

- Check all connections.

CHARGER: No charging despite shore power connection.

Possibility A: One or more batteries are defective.

- Check all connected batteries and replace them if necessary.

Possibility B: A battery fuse is defective.

- Check all fuses and replace them if necessary.

Possibility C: A battery cable is defective or damaged.

- Check all cables and replace them if necessary.

Possibility D: The charger is defective.

- If none of the other solutions solve the problem, please contact our customer service.

Any questions?

If you encounter problems that you cannot solve yourself, please contact our customer service. They will provide you with qualified help!

active.de/kontakt

Technical Specifications

	SSI 10 PRO	SSI 15 PRO	SSI 20 PRO	SSI 25 PRO	SSI 30 PRO
Continuous power	1000 W	1500 W	2000 W	2500 W	3000 W
Max. Power up to 2 s	2000 W	3000 W	4000 W	5000 W	6000 W
Max. Power up to 10 s	1500 W	2250 W	3000 W	3750 W	4500 W
Input voltage	12 V				
DC Connection	M8	M8	M10	M10	M10
Output voltage	230 V (max. 10 % AC voltage fluctuations), 50 Hz \pm 1 Hz				
Efficiency (inverter)	up to 92 %				
Charge voltage	10,2 to 15,0 V (depending on battery technology and charging phase)				
USB Port	5 V / 1 A				
Charge current	20 A	30 A	30 A	40 A	40 A
Efficiency (charger)	up to 92 %				
MPPT: charge current	40 A	40 A	40 A	40 A	40 A
MPPT: solar input voltage	25 to 75 V				
MPPT: Max. solar input power	600 W				
MPPT: efficiency	up to 97 %				
Weight	6,0 kg	7,0 kg	8,3 kg	8,9 kg	9,3 kg
Length	405 mm	430 mm	475 mm	505 mm	515 mm
Width	220 mm	220 mm	220 mm	220 mm	220 mm
Height	150 mm	150 mm	150 mm	150 mm	150 mm
Overheat threshold	>75 °C				
Overvoltage	$16,5 \pm 0,2$ V				
Return after overvoltage	$15,2 \pm 0,2$ V				
Impending unervoltage	$10,8 \pm 0,2$ V				
Actual undervoltage	$10,2 \pm 0,2$ V				
Undervoltage (ECO Mode, only with shore power)	$11,0 \pm 0,2$ V				
Return after undervoltage	$14,2 \pm 0,2$ V				
Working temperature	-15 °C to 40 °C				
Storage temperature	-40 °C to 85 °C				
Relative humidity	20 % to 90 %				

The SSI PRO in the ECTIVE Eco System

The ECTIVE SSI PRO series inverters fit perfectly into the ECTIVE ecosystem, as they are compatible with all ECTIVE solar panel series and ECTIVE batteries of all technologies. As powerful charge controllers and MPPT solar charge controllers are installed directly, no additional devices are required to charge supply batteries or utilise solar power. This means that nothing stands in the way of an absolutely self-sufficient and mobile power supply, which only includes high-quality and perfectly harmonised ECTIVE products. By the way: the modern ECTIVE RC PRO remote control can be used for convenient operation and monitoring of the relevant values.

Would you like to add the right ECTIVE components to your system? We have put together a few suggestions here! Find out more at active.de!

ECTIVE RC PRO

The ECTIVE RC PRO remote control is simply connected to the ECTIVE PRO inverter via an RJ12 cable and shows many relevant system values on a clear display:

- Current mode (ECO or UPS)
- Battery charge level
- Input and output voltage
- Power output
- Temperature
- Solar and shore power



You can easily switch between ECO and UPS mode at any time at the touch of a button, even if the inverter is not directly accessible.

Please note: The conventional ECTIVE RC1, RC2, RC3 and RC4 models are **not** compatible with PRO series inverters.

ECTIVE Batteries

In combination with ECTIVE PRO inverters, modern ECTIVE LiFePO4 batteries are ideal for a reliable and efficient stand-alone power supply. The LC Slim BT, LC Under Seat BT and LC BT+LT series impress with their high maximum capacities, continuous discharge currents, practical Bluetooth function and numerous other features. Of course, you can also use batteries with other technologies (e.g. AGM or gel). Please note the capacity recommendations on p. 11.



ECTIVE LC Under Seat BT



ECTIVE LC BT



ECTIVE LC Slim BT

ECTIVE Solar Panels

ECTIVE PRO inverters support solar panels up to 600 W and are therefore compatible with the entire ECTIVE solar panel range. Whether lightweight, flexible or portable for absolute independence: ECTIVE has the right solar panel series for every application.



ECTIVE SSP Black Lightweight



ECTIVE SSP Black Flex



ECTIVE SunDock

Service and Complaints

If you have any questions about your device after purchase or during operation, we are happy to help you. To speed up the process, please provide information by email in advance, whenever possible with an explanation of the issue and photos. To contact us and for product returns, please use the following service address:

batterium GmbH, Robert-Bosch-Straße 1,
71691 Freiberg am Neckar, Germany
T: +49 7141 / 560 90 40
info@ective.de
ective.de

Tip: When contacting us directly, please have your customer or invoice number and the article number ready.

In case you would like to return a product to us, please follow these guideline to ensure a quick and secure handling of the issue

- If possible use the original packaging as shipping carton.
- If you no longer have the original packaging, please use suitable (UN-certified) packaging to ensure adequate protection during transport.
- If the goods are not shipped in the original packaging or a UN-certified packaging, the goods are considered damaged and will therefore need to be billed when the item is returned.

Please enclose the following with the return shipment:

- Copy of the invoice
- (Service Form)
- Reason for return
- An exact and detailed error description

Warranty

3 YEARS
WARRANTY

The ECTIVE manufacturer's guarantee:
Because we are convinced of our products.

We are convinced of the quality of our products! That's why we grant a voluntary manufacturer's warranty on many ECTIVE batteries, solar panels and inverters in addition to the statutory warranty. Naturally, the inverters in the TSI PRO series are also covered by this voluntary warranty - with a validity period of three years after purchase!

You can find more detailed information on the warranty conditions in the support area for ECTIVE PRO inverters:

active.de/mediafiles/Datenblatt/active/Inverter-2024/Herstellergarantie-ECTIVE-Wechselrichter-Pro.pdf

Disposal

- Please dispose of all packaging material correctly or recycle it.
- In Germany, the Electrical and Electronic Equipment Act [ElektroG] regulates the placing on the market, disposal and disposal and recycling of electrical and electronic appliances.
- When decommissioning the appliance, please contact the nearest recycling centre or your point of sale and ask for information about the current disposal regulations.



Stay in Touch!

You would like to learn more about ECTIVE and our products? Visit our [Website!](#)

You want to stay up to date or are looking for inspiration for your next camper conversion? Follow us on [Instagram!](#)

Still have a specific question? Our [Customer Service Team](#) will be happy to take care of you. There you will receive fast, qualified help with concerns about our products!

Our goal is to make your life easier with our ECTIVE products. No matter if you are on the road with your camper, your boat or just your backpack. No matter if it's a trip, a festival or a professional photo shoot: You should be able to fully concentrate on your adventure or project. A reliable power supply that runs efficiently and safely in the background strengthens your back and you can take care of the essentials: Experiencing unforgettable moments and creating priceless memories.



batterium GmbH

Robert-Bosch-Straße 1 | 71691 Freiberg am Neckar | Germany
T: +49 7141 1410870 | info@ective.de | ective.de

© batterium GmbH, Edition 1, 05/2024